



CROSSRAY⁺
by HEATSTRIP[®]

ELECTRIC BARBECUE GRILL

OPERATING AND ASSEMBLY INSTRUCTIONS

Model TCE 15F



- Failure to comply with these instructions could result in a fire or electric shock that could cause serious bodily injury or property damage.
- **WARNING:**
NOT FOR COMMERCIAL USE.
DO NOT IMMERSE IN WATER.
DO NOT EXPOSE TO RAIN.
- Whether this grill was assembled by you or someone else, you must read this entire manual before using your grill to ensure the grill is properly assembled, installed and maintained.
- Your grill will get very hot. Always wear a flame retardant BBQ mitt when cooking on your grill.
- Never lean over cooking areas while using grill. Do not touch cooking surfaces, lid, grill housing or other parts while grill is in operation, or until the grill has cooled down after use.
- Use your grill at least 600 mm from combustible objects that can melt or catch fire (such as vinyl or wood siding, fences and overhangs) or sources of ignition including pilot lights on water heaters and live electrical appliances.

TABLE OF CONTENTS

| | |
|------------------------------|------|
| General Information / Safety | 2-4 |
| Operation | 5 |
| Cleaning and Maintenance | 6 |
| Guide to Grilling | 7 |
| Troubleshooting | 8 |
| Parts List / Diagram | 9-10 |
| Warranty | 11 |

IMPORTANT SAFEGUARDS



WHEN USING THIS GRILL OR ANY ELECTRICAL APPLIANCES, BASIC SAFETY PRECAUTIONS SHOULD ALWAYS BE FOLLOWED INCLUDING THE FOLLOWING:

- READ ALL INSTRUCTIONS
- USE GRILL ON A LEVEL, STABLE SURFACE
- DO NOT TOUCH HOT SURFACES. USE HANDLES OR KNOBS
- TO PROTECT AGAINST ELECTRICAL SHOCK DO NOT IMMERSE CORD, PLUGS, OR THIS GRILL IN WATER OR ANY OTHER LIQUID
- CLOSE SUPERVISION IS NECESSARY WHEN ANY APPLIANCE IS USED BY OR NEAR CHILDREN AND/OR PETS
- UNPLUG FROM OUTLET WHEN NOT IN USE AND BEFORE CLEANING
ALLOW TO COOL BEFORE PUTTING ON OR TAKING OFF PARTS
- DO NOT OPERATE ANY APPLIANCE WITH A DAMAGED CORD OR PLUG. DO NOT OPERATE ANY APPLIANCE IF IT CANNOT BE OPERATED SAFELY OR IF IT WAS BEEN DAMAGED IN ANY MANNER. RETURN APPLIANCE TO THE NEAREST AUTHORIZED SERVICE FACILITY FOR EXAMINATION, REPAIR, OR ADJUSTMENT.
- THE USE OF ANY ACCESSORY ATTACHMENTS UNAUTHORIZED BY THERMOFILM MAY CAUSE INJURIES, PROPERTY DAMAGE, OR DEATH
- DO NOT LET CORD(S) TOUCH HOT SURFACES DO NOT PLACE ON OR NEAR A HOT GAS OR ELECTRICAL BURNER, OR IN A HEATED OVEN
- DO NOT LET CORD(S) HANG OVER TABLE OR COUNTER EDGES. SECURE CORD(S) AND PLACE CORD(S) SO THAT IT CAN NOT BE TRIPPED OVER OR EASILY PULLED
- DO NOT MOVE THE APPLIANCE WHEN IT IS IN USE. ALLOW THE APPLIANCE TO COOL BEFORE MOVING OR STORING
- USE FLAME RETARDANT BBQ MITTS WHEN HANDLING ANY RECEPTACLE CONTAINING HOT OIL OR LIQUIDS
- TO DISCONNECT, TURN THE CONTROL KNOBS TO 'OFF', THEN REMOVE THE PLUG FROM THE WALL OUTLET
- DO NOT USE THE APPLIANCE FOR ANY PURPOSES OTHER THAN ITS INTENDED USE. DO NOT ALTER THIS APPLIANCE IN ANY WAY
- DO NOT USE THE APPLIANCE AS A HEATER
- NEVER USE CHARCOAL, LIGHTER FLUID, OR ANY FUEL IN THIS APPLIANCE.

- NEVER LINE THE BOTTOM OF THE GRILL HOUSING WITH ALUMINIUM FOIL OR ANY SUBSTANCE THAT WILL RESTRICT THE FLOW OF GREASE INTO THE GREASE RECEPTACLE
- GREASE RECEPTACLE MUST BE INSTALLED DURING GRILL USE
- DO NOT LEAVE GRILL UNATTENDED WHEN IT IS IN USE
- IF AN EXTENSION CORD IS USED:
 - 1) THE MARKED ELECTRICAL RATING OF THE EXTENSION CORD SHOULD BE AT LEAST AS GREAT AS THE ELECTRICAL RATING OF THE APPLIANCE.
 - 2) THE EXTENSION CORD SHOULD BE ARRANGED SO THAT IT WILL NOT DROP OVER THE COUNTER TOP OR TABLETOP WHERE IT CAN BE PULLED ON BY CHILDREN OR TRIPPED OVER UNINTENTIONALLY.
 - 3) THE APPLIANCE MUST BE PROPERLY GROUNDED. THE EXTENSION CORD SHOULD BE A GROUNDING-TYPE 3 WIRE CORD.
- USE AN EXTENSION CORD SUITED FOR OUTDOOR USE
- STORE THIS UNIT INDOORS OUT OF THE REACH OF CHILDREN WHEN NOT IN USE
- DO NOT CLEAN THIS PRODUCT WHEN IT IS IN USE OR PLUGGED INTO A POWER SOURCE.
- CHILDREN BEING SUPERVISED ARE NOT TO PLAY WITH THIS APPLIANCE
- IF THE SUPPLY CORD IS DAMAGED, IT MUST BE REPLACED BY THE MANUFACTURER, IT'S SERVICE AGENT OR SIMILARLY QUALIFIED PERSONS IN ORDER TO AVOID A HAZARD
- **WARNING:** CHARCOAL OR SIMILAR COMBUSTIBLE FUELS MUST NOT BE USED WITH THIS APPLIANCE

SAVE THESE INSTRUCTIONS.



THE GREASE RECEPTACLE MUST BE VISUALLY INSPECTED BEFORE EACH GRILL USE. REMOVE ANY GREASE AND WASH GREASE RECEPTACLE WITH A MILD SOAP AND WARM WATER SOLUTION.

PRE-ASSEMBLY

Read and perform the following pre-assembly instructions:

- Open lid of shipping carton and remove unit and packing materials. Open the grill lid and unpack parts inside. Remove and discard all packing materials from unit and parts.
- Do not assemble or operate the grill if it appears damaged. If there are damaged or missing parts when you unpack the shipping box or you have questions during the assembly process. Refer to back for service details.



DANGER:
ELECTRIC SHOCK CAN KILL OR RESULT IN SERIOUS INJURY.

TO PREVENT ELECTRICAL SHOCK:

- CONNECT CORD TO PROPERLY GROUNDED OUTLET ONLY
- THIS APPLIANCE SHOULD BE SUPPLIED THROUGH A RESIDUAL CURRENT DEVICE (RCD) HAVING A RATED RESIDUAL OPERATING CURRENT NOT EXCEEDING 30 mA
- THE SUPPLY CORD SHOULD BE REGULARLY EXAMINED FOR SIGNS OF DAMAGE AND THE APPLIANCE SHOULD NOT BE USED IF THE CORD IS DAMAGED
- NEVER OPERATE YOUR ELECTRIC GRILL WHEN IT IS RAINING
- ALWAYS KEEP CORD DRY AND OFF THE GROUND
- KEEP ELECTRICAL SUPPLY CORD AWAY FROM ANY HEATED SURFACES
- NEVER PUT THE CORD OR HEATING ELEMENT IN WATER OR ANY LIQUID
- TO PREVENT YOUR GRILL FROM BEING SPLASHED BY WATER OR FALLING INTO WATER, DO NOT USE GRILL WITHIN 3 METRES OF POOL, SPA, POND, WATER FAUCET OR ANY BODY OF WATER
- MAKE SURE THE CONTROL KNOBS ARE SET TO OFF BEFORE PLUGGING OR UNPLUGGING YOUR GRILL
- UNPLUG YOUR GRILL WHEN NOT IN USE OR BEFORE MOVING THE GRILL
- DO NOT UNPLUG YOUR GRILL BY PULLING THE CORD
- KEEP CORD AWAY FROM HOT GRILL SURFACES
- NEVER OPERATE YOUR GRILL IF THE CORD OR PLUG APPEARS DAMAGED
- NEVER REMOVE THE GROUNDING PLUG OR USE WITH AN ADAPTER TO TWO PRONGS.
- UNPLUG THE CORD BEFORE USING WATER OR ANY LIQUID TO CLEAN YOUR GRILL.



NOT FOR COMMERCIAL USE. DO NOT IMMERSE IN WATER OR EXPOSE TO RAIN.



YOUR GRILL WILL GET VERY HOT. DO NOT TOUCH COOKING SURFACES, LID, GRILL HOUSING OR OTHER PARTS WHILE GRILL IS IN OPERATION, OR UNTIL THE GRILL HAS COOLED DOWN AFTER USE.



THIS APPLIANCE IS NOT INTENDED FOR USE BY PERSONS (INCLUDING CHILDREN) WITH REDUCED PHYSICAL, SENSORY OR MENTAL CAPABILITIES, OR LACK OF EXPERIENCE OR KNOWLEDGE, UNLESS THEY HAVE BEEN GIVEN SUPERVISION OR INSTRUCTION CONCERNING USE OF THE APPLIANCE BY A PERSON RESPONSIBLE FOR THEIR SAFETY.

UNPACKING

Remove the grill from the carton and remove all the packaging.

The grease receptacle is located within the appliance. Remove and install from the rear / underneath as shown.

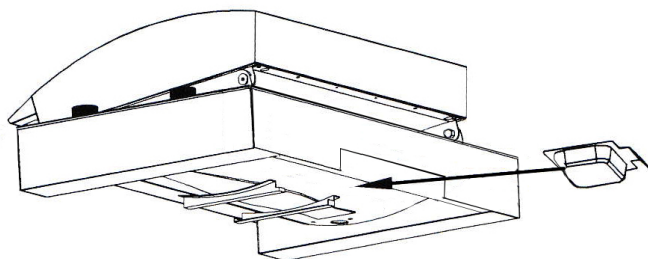

Remove the grill/hotplate from the protective wrapping, wash and dry before using. It is recommended that the grill/hotplate be wrapped in paper or removed if transported the appliance.



- FAILURE TO COMPLY WITH THESE INSTRUCTIONS COULD RESULT IN A FIRE OR EXPLOSION THAT COULD CAUSE SERIOUS BODILY INJURY, DEATH OR PROPERTY DAMAGE.
- KEEP A MULTI-PURPOSE FIRE EXTINGUISHER READILY ACCESSIBLE. IN THE EVENT OF A FIRE, TURN CONTROL KNOBS TO 'OFF' AND UNPLUG GRILL FROM OUTLET. NEVER USE WATER TO PUT OUT A FIRE IN THIS OR ANY OTHER ELECTRICAL APPLIANCE.
- THIS GRILL IS NOT INTENDED TO BE INSTALLED IN OR ON RECREATIONAL VEHICLES AND/OR BOATS.
- NEVER LINE THE BOTTOM OF THE GRILL HOUSING WITH CHARCOAL, ALUMINIUM FOIL, SAND OR ANY SUBSTANCE THAT WILL RESTRICT THE FLOW OF GREASE INTO THE GREASE RECEPTACLE.
- BEFORE EACH USE OF YOUR GRILL PULL OUT THE GREASE RECEPTACLE AND REMOVE ALL GREASE AND FOOD DEBRIS TO PREVENT GREASE FIRE HAZARD.
- USE YOUR GRILL AT LEAST 600 mm AWAY FROM COMBUSTIBLE OBJECTS THAT CAN MELT OR CATCH FIRE (SUCH AS VINYL OR WOOD SIDING, FENCES AND OVERHANGS) OR SOURCES OF IGNITION INCLUDING PILOT LIGHTS ON WATER HEATERS AND LIVE ELECTRICAL APPLIANCES.

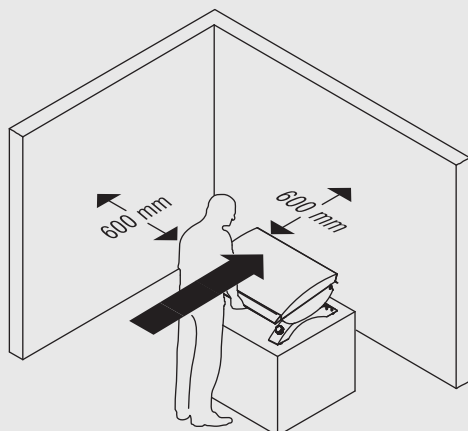

GROUNDING

This appliance must be grounded while in use to protect the operator from electrical shock. The appliance is equipped with a 3-conductor cord and 3 prong grounding-type plug to fit the proper grounding-type receptacle.

EXTENSION CORDS

1. Only use a 3-wire extension cord that has a 3-prong grounding-type plug and 3-prong cord connector that accepts the plug from the appliance.
2. Only use extension cords that have an electrical rating no less than the rating of the appliance.
3. Do not use damaged extension cords. Examine cord before using and replace if damaged. Do not abuse extension cord.
4. Do not tug on the cord to disconnect it from appliance or power source.
5. Keep cord away from heat and sharp edges.
6. Keep connection to extension cord dry and off the ground.
7. Never use more than one extension cord to plug appliance to power source.



INFRARED LAMPS AND GRILL SURFACES MAY STILL BE HOT EVEN IF HEAT ON LAMP IS OFF.

CAUTION: Remove the grease receptacle before moving grill. Use caution when handling receptacle or serious injury may occur. Receptacle must be installed for grill operation.

SPECIFICATION AND WIRING DIAGRAM FOR BIGW EGrill

AC POWER: 230 - 240 V AC ~ 50 Hz 7A, 1500 W



IF ANY OF THE ORIGINAL WIRING SUPPLIED WITH THE APPLIANCE NEEDS TO BE REPLACED, CONTACT THERMOFILM AUSTRALIA PTY.LTD. FOR REPLACEMENT ON 03 9562 3455 MON-FRI 8.30am-5.00 pm EST

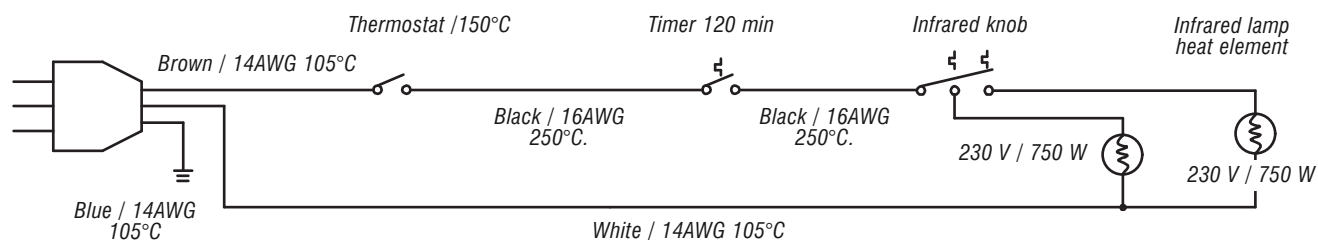

TURNING GRILL ON

1. Make sure the control knobs are set to 'OFF'.

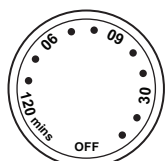

Timer knob

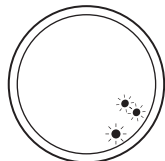

Infrared knob

2. Disconnect other appliances from the circuit before using your grill.
3. Check the grease receptacle for any grease. If it has grease, remove the receptacle and clean with a warm soap and water solution. Reinstall the receptacle after it has been thoroughly cleaned and dried. (See 'Installing Grease Receptacle' for correct installation of receptacle.)
4. Plug grill into properly grounded outlet.
5. To set the timer to desired time, turn timer knob past the 120 minute mark and then back to your desired time. Turn Infrared knob to ☀ keep lid closed.

☀ Setting the knob to ☀ turns on the back lamp. This is the lower heat setting.

☀☀ Setting the knob to ☀☀ turns on both lamps. This is the highest heat setting.

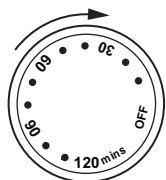

Timer knob

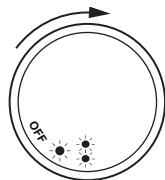

Infrared knob

6. Allow the grill to preheat for no more than 15 minutes with the lid closed. Open lid and place food on the grill plate / hot plate once preheating is finished.

PREHEATING

Preheating the grill increases the grill surface temperature and reduces the actual cooking time. Preheat the grill with the lid closed for app.15 minutes, or until the gauge registers 200C.

IMPORTANT: AUTO SWITCH OFF MODE

This grill has been designed with a safety feature that will automatically shut off the grill once the internal air temperature of the grill reaches 300°C.

This grill will also shut itself off once the end of the set time period has been reached.

NOTE: The suggested heat settings and cooking times shown on the Guide to Grilling on page 8 are approximate. Variables including outside temperatures, direction and conditions of wind, as well as grill location will affect your grill's heat distribution. Because these conditions vary, we offer this guide as a convenience.

We recommend you monitor your grill closely and rotate foods as needed to prevent overcooking and ensure the most delicious results every time.

Proper care and maintenance will keep your grill in top operating condition and prolong its life. Follow these cleaning procedures on a timely basis and your grill will stay clean and operate with minimum effort.

CAUTION: *Be sure your grill is OFF, unplugged, and cool before cleaning.*

CLEANING THE GRILL PLATE & HOT PLATE

Before initial use and periodically after, wash the grill plate and hot plate in a mild soap and warm water solution. You can use a wash cloth or vegetable brush to clean your grill plate and hot plate. Dry each thoroughly before reinstalling back in the grill.

CLEANING THE GREASE RECEPTACLE

To reduce the chance of fire, the grease receptacle must be visually inspected before each grill use. Remove the grease receptacle from the grill. Remove any grease and wash the grease receptacle with a mild soap and warm water solution. Dry the receptacle thoroughly before reinstalling.

CLEANING THE INSIDE OF THE GRILL LID

Grease can build up on the inside of the lid. Visually inspect the inside of the grill lid before each grill use. Unplug the unit and use a wet washcloth to remove any grease. Leave the lid open and let the grill dry before using it again.

CLEANING EXTERIOR PAINTED SURFACES

Before initial use and periodically thereafter, we suggest you spot clean your grill's exterior using a mild soap and warm water solution. (Do not immerse the grill or cord in water.) You can use a wash cloth or sponge for this process. Do not use a stiff wire or brass brush. These will scratch stainless steel and chip painted surfaces during the cleaning process. Unplug the unit (grill must be completely cool) before cleaning exterior surfaces. Let the unit completely dry before cooking.

CLEANING THE INSIDE OF THE GRILL

NOTE: *To aid cleaning, the inside of the grill may be lined with aluminium foil.*

Remove the cooking plate/s and reflectors (See: CLEANING THE REFLECTORS). Cut a piece of aluminium foil 340 x 425 mm and slide in under the heating elements. Push down to take the form of the bottom of the grill. With your finger, push a hole into the foil at the grease drain hole position to allow grease to flow into the grease receptacle.

Remove the cooking plate and reflectors. Wipe the inside of the grill clean with hot soapy water and a soft cloth. Be careful not to damage the elements.

Dry with a clean cloth. To ensure completely dry, switch the grill on with the hood down for 4 - 5 minutes.

CLEANING THE REFLECTORS

NOTE: *Reflectors must be removed before cleaning.*

After each use remove the heat reflectors and wash thoroughly to remove all fat and food residues – an 'oven cleaner' may be used to remove stubborn residues.

Do not use abrasive cleaners which can dull the surface.

Keeping the reflectors surface clean and bright will maintain the cooking efficiency.

To remove the reflectors, first remove the cooking plate, then slide the reflectors out – one from the front, one from the rear.

GRILLING STEAK

Preheat the grill using the highest setting for 15 minutes. Open lid and place the meat on the grill plate / hot plate. Cook the meat on both sides until seared. Maintain high heat and cook until done. Grilling times will vary according to meat thickness.

GRILLING HAMBURGERS

Preheat the grill using the highest setting for 15 minutes. Open lid and place the meat on the grill plate / hot plate. Cook the meat on both sides until seared. Maintain heat and cook until done. Grilling times will vary according to meat thickness.

GRILLING POULTRY

Preheat the grill using the highest setting for 15 minutes. Open lid and place the poultry on the grill plate / hot plate. Cook the poultry on both sides until seared. Maintain heat and cook until done. Grilling times will vary according to poultry thickness.

Poultry skin is fatty so you should expect some flare-ups. You can choose to remove the skin or excess fat to prevent these flare ups.

GRILLING PORK

Preheat the grill using the highest setting for 15 minutes. Open lid and place the meat on the grill plate / hot plate. Cook the meat on both sides until seared. Maintain heat and cook until done. Grilling times will vary according to meat thickness.

GRILLING FISH

Preheat the grill using the highest setting for 15 minutes. Open lid and place fish (skin down) on the grill plate /hot plate. Cook the fish on both sides until seared. Cook until fish is opaque but still moist.

VEGETABLES AND FRUIT

Preheat the grill using the highest setting for 15 minutes. Open lid and place food on the grill plate / hot plate. Vegetables and fruit that work best on the grill are relatively soft and require a short cooking time: mushrooms, zucchini, tomatoes and skewered fruit such as apricots, peaches and pineapple.

For very firm vegetables – particularly potatoes – we recommend that you partially boil until almost cooked, before placing them on the grill. Cooking times will be comparable to normal pan frying.

IF THE GRILL FAILS TO PRODUCE ANY HEAT

1. Be sure there is power to the grill. Turn the control knobs off and try the following:
 - Plug cord into properly grounded outlet.
 - Outlet may be faulty. Try another outlet.
 - Make sure the grill is on a dedicated outlet. The grill cannot be used if there is another device plugged into the outlet.
2. Control knob(s) may be in 'OFF' position.
 - Turn Infrared knob to . Turn timer knob to desired time (see page 6 for more details).
3. Heating element may need replacing.
 - Call Thermofilm to order replacement parts and only use certified replacement parts.
4. The internal heating element will automatically shut itself off after the set time limit has been reached.
 - To reset the internal timer, turn the control knobs to 'OFF' and unplug the cord from the power outlet. Plug the cord back in and turn the timer and Infrared knobs on.
5. The internal heating element will automatically shut itself off if the internal air temperature of the grill reaches 300°C.
 - Check to see if the timer knob has reached zero (0). If it hasn't reached zero (0), open the lid to cool the grill down. The power should automatically start after approximately 10 minutes (this figure may vary if the grill is used in hotter climates).

IF THE GRILL COOKS TOO SLOWLY

1. Always preheat the grill with the lid closed before putting food into the grill.
2. If it is windy, reposition the grill to reduce its effects.
3. Infrared knob may be set too low.
 - Turn infrared knob to .

IF THE HEAT "ON" LIGHT IS OFF

1. Be sure there is power to the grill.
2. Control knobs may be in 'OFF' position.
 - Set Infrared knob to desired setting. Set timer knob to desired time.
3. Auto knob has been triggered (internal temperature of grill has reached 300°C).
 - Do not preheat on the highest setting with the lid closed for more than 15 minutes. Open the lid to cool the grill down. The grill should restart automatically after about 10 minutes.
4. Heat ON light or heating element may need replacing.
 - **Contact Thermofilm for replacement.**

CIRCUIT BREAKER CONTINUES TO TRIP

1. Caused by a power surge
 - Make sure the control knobs are set to 'OFF' before plugging OR unplugging your grill.
2. Circuit may be overloaded with appliances.
 - Disconnect other appliances from the circuit when using your grill.
3. Electrical connections may be damp or wet.
 - Always keep cord dry and off the ground.
 - Never put the cord or heating element in water or any liquid.
 - If the grill is outdoors, do not use it when it is raining.
 - If the grill is being used in a humid area, it may take a day or more for electrical circuits to thoroughly dry before the breaker will reset. This is not a defect of the product.
4. Electrical cord may be damaged. Never operate your grill if the cord or plug appears to be damaged.
 - **Contact Thermofilm for replacement .**

IF YOU HAVE EXCESSIVE FLARE-UPS WHEN COOKING:

1. The fats and juices dripping from grilled food can cause flare-ups. To minimise flare-ups try the following:
 - Trim excess fat from meat before grilling.
 - Consider choosing leaner cuts of meat for cooking.
 - Use a lower temperature setting.
2. Grease and food build up inside your grill and grease receptacle.
 - Be sure your grill is turned off, unplugged, and completely cool. Follow the 'Cleaning and Maintenance' steps found in this manual to clean the grill plate / hot plate, grease receptacle, and inside of bowl and lid.

Thermofilm Australia Pty. Ltd. will warrant to the ORIGINAL PURCHASER of this product that it will be free of defects in material and workmanship for set periods below from the date of purchase when used under normal outdoor use and correct assembly:

Full Warranty on Grill – 1 Year (except for paint loss and rusting).

Cooking grill plate / hot plate – 2 Year Limited Warranty, no rust through.

Stainless Steel Parts – 3 Year Limited Warranty, no rust through.

Thermofilm Australia Pty. Ltd. will require reasonable proof of your date of purchase. Save your receipt in case it is required as proof of purchase.

This Limited Warranty is limited to replacement of parts at **Thermofilm Australia Pty. Ltd** option that proved to be defective under normal use and service.

Thermofilm Australia Pty. Ltd may require the return of defective parts for examination before issuing replacement parts. If you are required to return defective parts, shipping charges must be prepaid. No returns will be accepted without prior authorization from **Thermofilm Australia Pty. Ltd.**

Upon examination and to **Thermofilm Australia Pty Ltd's** satisfaction, if the original part is proven defective, **Thermofilm Australia Pty. Ltd.** may approve your claim and elect to replace such parts without charge. You will be charged for shipping and handling of the replacement parts.

This Warranty does not cover any failures or operating difficulties due to accident, abuse, misuse, alteration, misapplication, vandalism, improper installation, maintenance, operation or service, as set out in the Operator's Manual.

This Warranty does not cover cosmetic wear and tear such as scratches, dents, corrosion or discolouration caused by weather, heat, chemicals, paint loss, or surface rust. Deterioration or damage due to severe weather conditions such as hail, hurricanes, earthquakes, tsunamis, tornadoes, Act of God or terrorism is not covered by this Limited Warranty.

TO OBTAIN WARRANTY

Call **03 9562 3455**

Monday-Friday 8.30am - 5.00 pm EST

WARRANTY RESTRICTIONS

This Warranty is non-transferable and is void if product is used for commercial or rental purposes.

This Warranty applies only when the product is used in Australia.

This Warranty gives you specific legal rights, and you may also have other rights which vary from state to state.

FOR CUSTOMER REFERENCE

(Record and file in a safe place)

Purchased from _____

Date purchased _____

Serial No. _____

| <i>Ref</i> | <i>DESCRIPTION</i> | <i>PART#</i> | <i>QTY</i> |
|------------|------------------------------|--------------|------------|
| 1 | Hood assembly | S0208-10 | 1 |
| 2 | Hood handle | P00202024A | 1 |
| 3 | Protective pad | P05518105I | 4 |
| 4 | Wire waterproof box | P03350002D | 2 |
| 5A | Cooking grid | P01615041E | 1 |
| 5B | Hot plate | P05701008E | 1 |
| 6 | Lamp protective grid | S0213-04 | 1 |
| 7 | Halogen tube element, 750w | S0213-05 | 2 |
| 8 | Heat reflector | P01704002A | 2 |
| 8a | Heat reflector bracket, rear | P03303142L | 1 |
| 9 | Lamp protective plate, left | S0213-01A | 1 |
| 10 | Lamp protective plate, right | S0213-01B | 1 |
| 11 | Lamp support bracket, left | P03311050D | 1 |
| 12 | Lamp support bracket, right | P03311051D | 1 |
| 13a | Wire heat shield, left | S0211-02A | 1 |
| 13b | Wire heat shield, right | S0211-02B | 1 |
| 14 | Bowl assembly | P0071383AB | 1 |
| 15 | Bowl support bracket- Rear | S0208-01 | 1 |
| 16 | Grill leg assembly, left | S0208-02 | 1 |
| 17 | Grease receptacle | P02701327B | 1 |
| 18 | Control knob for timer | S0208-04 | 1 |
| 19 | Control knob for lamp | S0208-05 | 1 |
| 20 | Bowl support bracket- front | S0208-06 | 4 |
| 21 | Hood hinge set | P05501141M | 1 |
| 22 | Grill leg cover, left | S0208-07 | 1 |
| 23 | Grill leg cover, right | S0208-08 | 1 |
| 24 | Temperature gauge | S0208-09 | 1 |

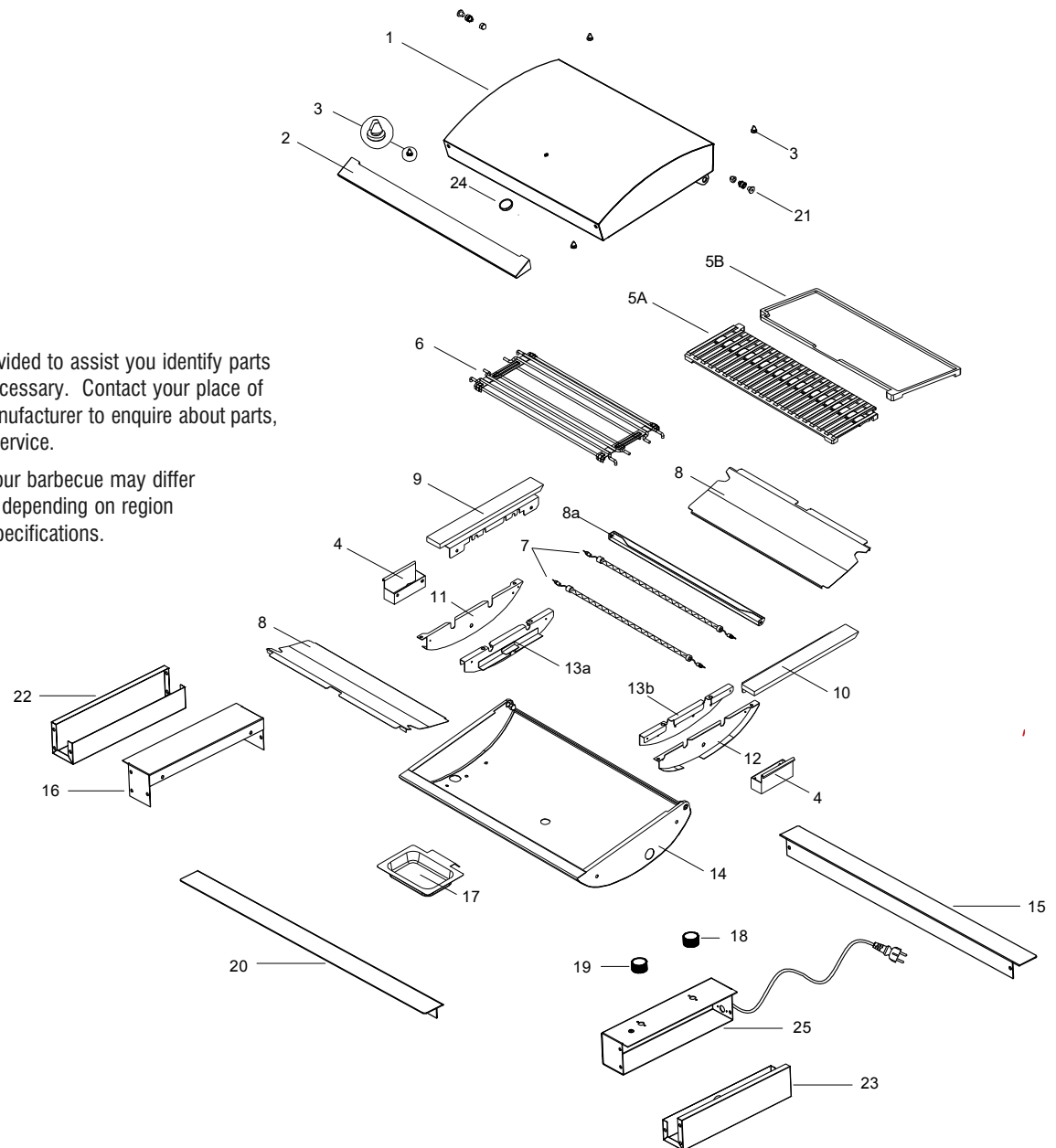

This diagram is provided to assist you identify parts if replacement is necessary. Contact your place of purchase or the manufacturer to enquire about parts, availability and/or service.

Items included in your barbecue may differ from the Parts List, depending on region or specific dealer specifications.

PRIVACY POLICY

THERMOFILM AUSTRALIA Pty. Ltd. may collect personal information about a consumer of its products in the course of receiving or responding to a warranty claim. Such information is only collected to enable the resolution of the warranty claim to the consumer's satisfaction, and is not disclosed to other organisations except service agents or sometimes the applicable retailer.

THERMOFILM AUSTRALIA PTY. LTD.

17 Johnstone Court
Dandenong South, Victoria 3175 Australia

P: +61 (0) 3 9562 3455

F: +61(0)395483979

www.thermofilm.com.au

Email - sales@thermofilm.com.au

All specifications are subject to change
without notice.



Thermofilm Australia Pty Ltd
17 Johnston Court Dandenong South, Victoria, 3175 Australia
t: 03 9562 3455 e:sales@thermofilm.com.au